

# LED Street Light

## SL40 Series



**Shenzhen LAMIN Optoelectronic Co., Ltd**

9 Fu'rui Road, Dayangtian Development Zone, Fuyong Town,  
Bao'an District, Shenzhen, Guangdong, 518103, China



[www.hklamin.com](http://www.hklamin.com)

# SL40 Street Light

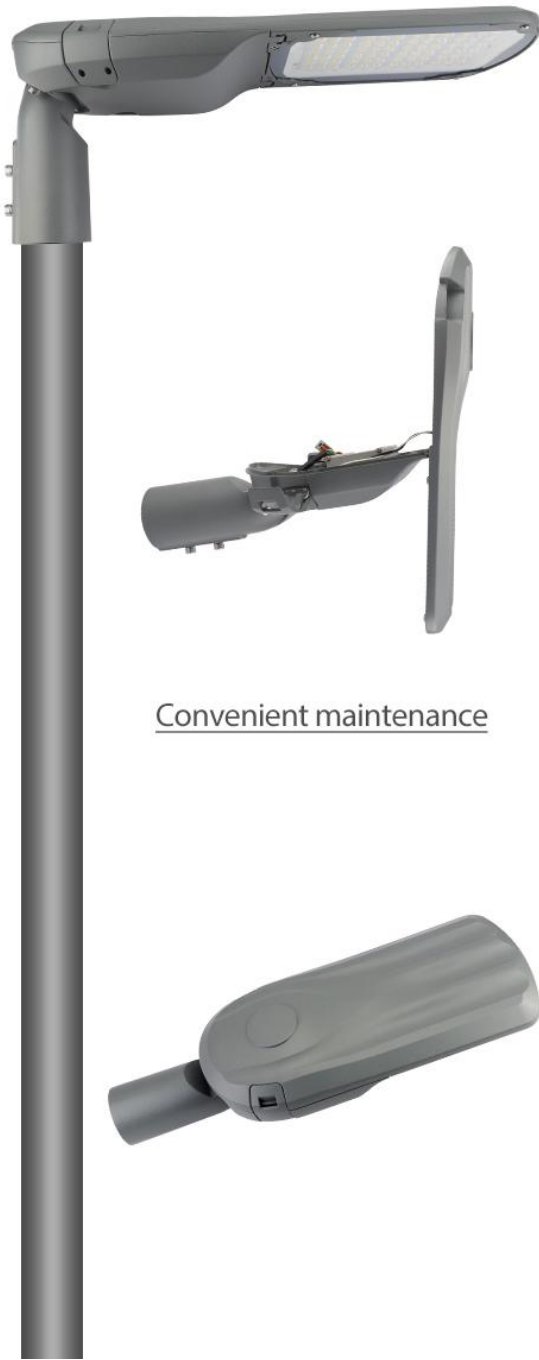

Convenient maintenance

## Key Features

- Super slim tight design, housing has less effect to lighting effect of optic lens
- Much nicer, even, wider higher lighting effect
- With branded LEDs and driver, 150-170lm/w super high efficiency
- IP66 dual ingress protection (lens+temper glass), IK08 guaranteed
- Driver box and lighting part separately sealed, more efficient and safe
- Buckle-lock, tool-free maintenance
- Curved back, dust-free, self-cleaning
- Adjustable adaptor ( $\pm 15$  degree), suit adjusting demand of installation
- TM21 service life >50000hrs

## Application

Street, road, stadium, highway, bridge, sport yard, parking.

## Ordering Information

LMS80-SL40-DW

LM

Company Name

S

SMD

80

Power

SL

Street Light

40

Product Series

DW

5700K

# SL40 Street Light

## Dimension (unit: mm)

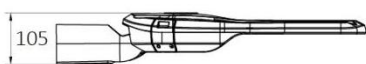
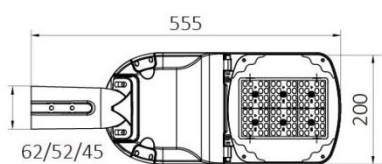

40W/50W/60W

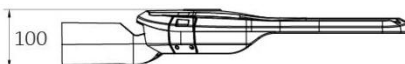
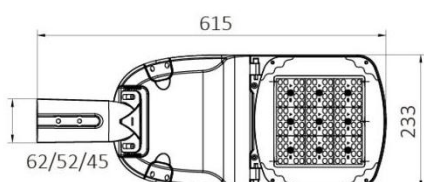

80W/100W

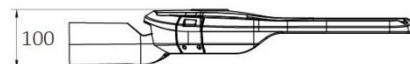
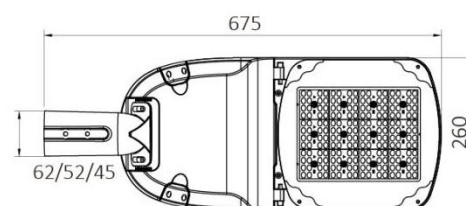

120W/150W

## Product Data

Model	LMS40-SL40	LMS50-SL40	LMS60-SL40	LMS80-SL40	LMS100-SL40	LMS120-SL40	LMS150-SL40
Wattage	40W	50W	60W	80W	100W	120W	150W
Lumen Output	6000lm	7500lm	9000lm	12000lm	15000lm	18000lm	22500lm
Luminous Efficacy	150lm/W						
CCT	3000K/4000K/5000K/5700K/6500K						
CRI	Ra≥70						
PF	> 0.9						
Input Voltage	100-277 VAC						
Housing Color	Light grey						
Housing Material	Aluminum(ADC12), lens+temper glass						
Operating Temperature	-30°C to +45°C						
IP Level	IP66						
Lifespan	50,000 hours						
Warranty	5 years						

# SL40 Street Light

## Photometry

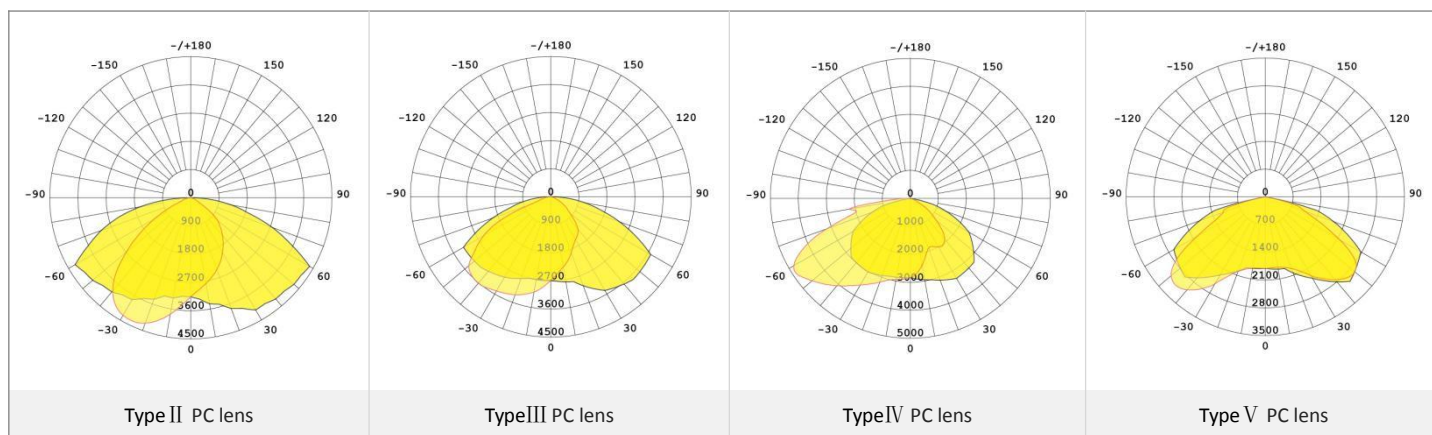

## Packaging

Model	PCS/CTN	Net Weight	Gross weight	Volumetric Weight	CBM
LMS40-SL40	1	3.35kg	3.82kg	3.66kg	L610×W240×H125mm≈0.019 <sup>3</sup>
LMS50-SL40	1	3.35kg	3.82kg	3.66kg	L610×W240×H125mm≈0.019 <sup>3</sup>
LMS60-SL40	1	3.35kg	3.82kg	3.66kg	L610×W240×H125mm≈0.019 <sup>3</sup>
LMS80-SL40	1	3.77kg	4.30kg	4.48kg	L650×W270×H125mm≈0.022 <sup>3</sup>
LMS100-SL40	1	3.77kg	4.30kg	4.48kg	L650×W270×H125mm≈0.022 <sup>3</sup>
LMS120-SL40	1	4.75kg	5.36kg	6.43kg	L710×W290×H125mm≈0.025 <sup>3</sup>
LMS150-SL40	1	4.75kg	5.36kg	6.43kg	L710×W290×H125mm≈0.025 <sup>3</sup>

# SL40 Street Light

## Installation

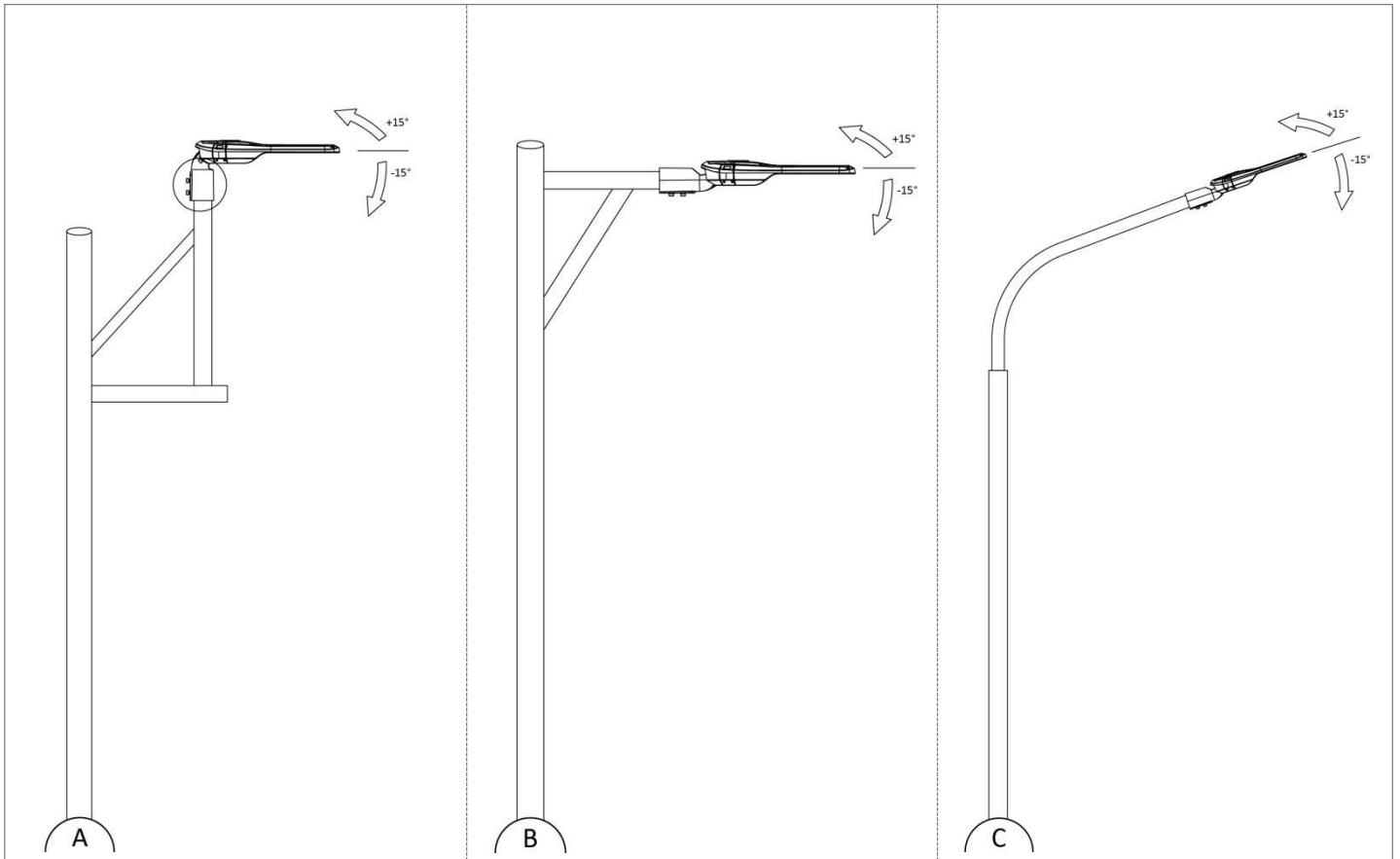

### ANSI

White cable for "N"

Green for ground wire

Black cable is for "L"

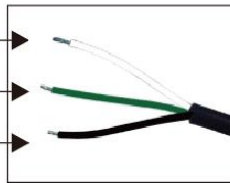

### EN

Blue cable for "N"

Brown cable is for "L"



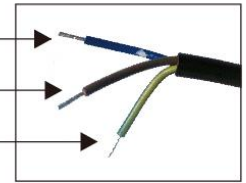



Green/Yellow for ground wire

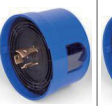
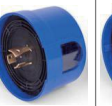
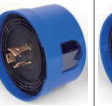
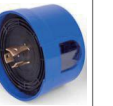

※ Note: If the lamp be used outside, please keep the connector water-proof.

# SL40 Street Light

## Shorting cap & photocell

LED fixtures match	photocell options		controller base							
			JL-208	JL-205C	JL207C	JL241C	JL251C	JL254C	Gateway box(P/V)	
			"shorting cap Φ73X41MM IP66"	"Analog electronic control three-wire 6Lx ON 50Lx OFF 10s delay Φ84X66MM AC100-277V "	"Digital electronic control three-wire 16Lx ON 24Lx OFF 5-20s delay Φ84X66MM M AC100-277 V"		"0-10V dimming seven-wire 50Lx ON 50Lx OFF 10s delay Φ84X66MM AC100-277V "	"Dali dimming seven-wire 50Lx ON 50Lx OFF 10s delay Φ84X86MM AC100-277V "	"Zigbee control(need work with gateway box) Dali dimming Midnight Dimming LED Decay Compensati on seven-wire 50Lx ON 50Lx OFF 5s delay Φ84X86MM AC100-277V "	remote control by using a gateway box connected to a smart phone(iOS/An driod) with blue tooth communicati on, while connected to the smart control(JL-25 4C) with Zigbee communicati on
										
"SL27,SL29,SL30, SL32,SL40 series non-dimmable"	JL-200X		"S:Φ65X38.5MM,0-480VAC, AWG18#:10A, AWG14#:15A, ULapproval, 3-wire 150MM (match non-dimming)"	✓	✓	✓				
"SL27,SL29,SL30, SL32,SL40 series 0-10V dimmable"	JL-240XB		"S:Φ65X40MM,0-480VAC, AWG18#: 10A, AWG14:15A, ULapproval, 5-wire 150MM (match 0-10V dimming)"	✓			✓			
"SL27,SL29,SL30, SL32,SL40 series 0-10V/ Dali dimmable"	JL-240XA		"S:Φ65X40MM,0-480VAC, AWG18#:10A, AWG14#:15A, ULapproval,7-wire 150MM (match 0-10V/dali dimming)"	✓	✓	✓	✓	✓	✓	