

LED Street Light

SL48 Series



Shenzhen LAMIN Optoelectronic Co., Ltd



9 Fu'ruì Road, Dayangtian Development Zone, Fuyong Town,
Bao'an District, Shenzhen, Guangdong, 518103, China



www.hklamin.com

SL48 Street Light



Convenient maintenance

Key Features

Five housing for 30W-300W

Build-in gradienter

Super slim tight design, housing has less effect to lighting effect of optic lens

Much nicer, even, wider higher lighting effect

With branded LEDs and driver, 150-170lm/w super high efficiency

IP66 dual ingress protection (lens+temper glass), IK08 guaranteed

Driver box and lighting part separately sealed, more efficient and safe

Buckle-lock, tool-free maintenance

Curved back, dust-free, self-cleaning

Adjustable adaptor (± 15 degree), suit adjusting demand of installation

TM21 service life >50000hrs

Application

Street, road, stadium, highway, bridge, sport yard, parking.

Ordering Information

LMS80-SL48-DW

LM

Company Name

S

SMD

80

Power

SL

Street Light

48

Product Series

DW

5700K

SL48 Street Light

Dimension (unit: mm)

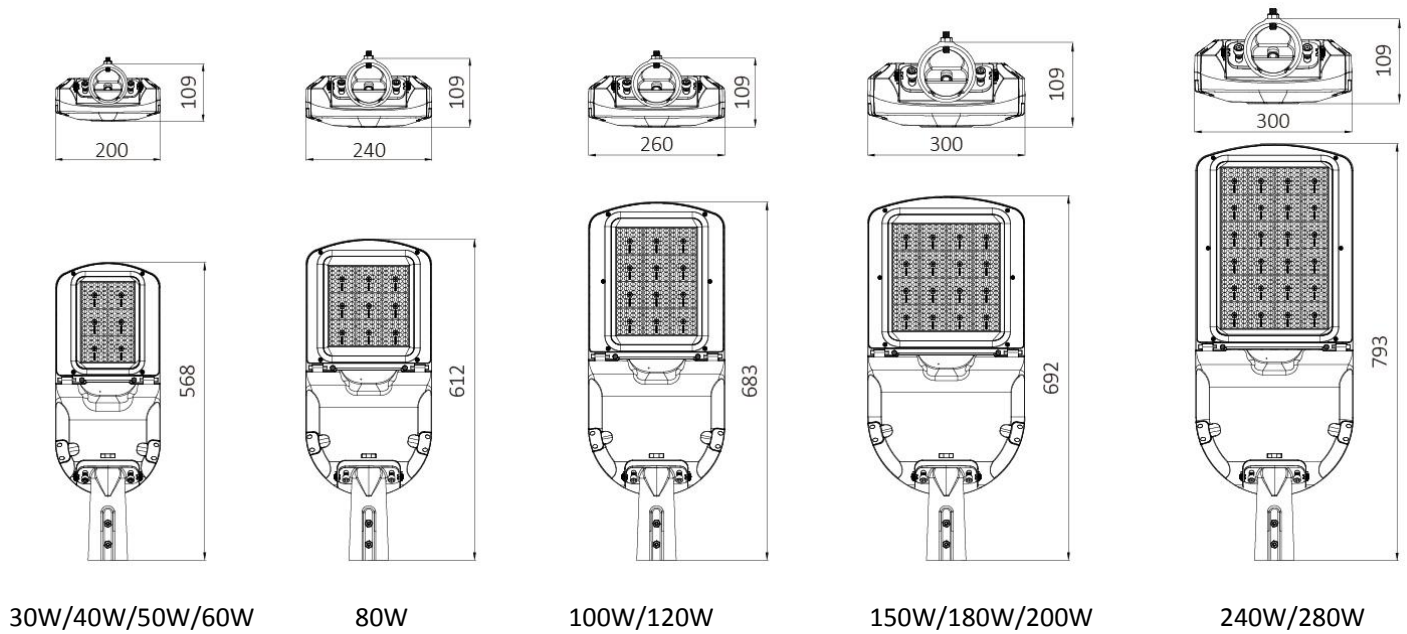

Product Data

Model	LMS30-SL 48	LMS40-SL 48	LMS50-SL 48	LMS60-SL 48	LMS80-SL 48	LMS100-SL48	LMS120-SL48	LMS150-SL48	LMS180-SL48	LMS200-SL48	LMS240-SL48	LMS280-SL48
Wattage	30W	40W	50W	60W	80W	100W	120W	150W	180W	200W	240W	280W
Lumen Output	4800lm	6400lm	8000lm	9600lm	12800lm	16000lm	19200lm	24000lm	28800lm	32000lm	38400lm	44800lm
Luminous Efficacy	160lm/W											
CCT	3000K/4000K/5000K/5700K/6500K											
CRI	Ra≥70											
PF	> 0.9											
Input Voltage	100-277 VAC											
Housing Color	Light grey											
Housing Material	Aluminum(ADC12), lens+temper glass											
Operating Temperature	-30°C to +45°C											
IP Level	IP66											
Lifespan	50,000 hours											
Warranty	5 years											

SL48 Street Light

Photometry

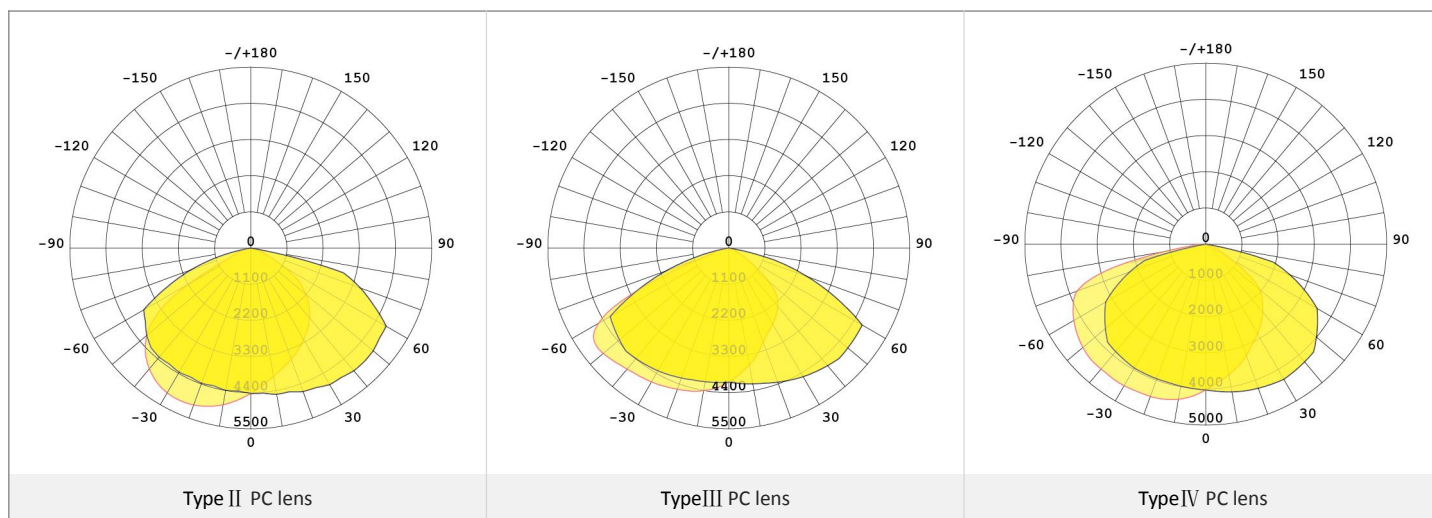

Packaging

Model	PCS/CTN	Net Weight	Gross weight	Volumetric Weight	CBM
LMS30-SL48	1	3.48kg	4.1kg	4.8kg	L623×W255×H150mm≈0.024 ³
LMS40-SL48	1	3.48kg	4.1kg	4.8kg	L623×W255×H150mm≈0.024 ³
LMS50-SL48	1	3.48kg	4.1kg	4.8kg	L623×W255×H150mm≈0.024 ³
LMS60-SL48	1	3.48kg	4.1kg	4.8kg	L623×W255×H150mm≈0.024 ³
LMS80-SL48	1	4.02kg	4.72kg	6.0kg	L666×W295×H150mm≈0.030 ³
LMS100-SL48	1	4.67kg	5.52kg	7.0kg	L736×W315×H150mm≈0.035 ³
LMS120-SL48	1	4.67kg	5.52kg	7.0kg	L736×W315×H150mm≈0.035 ³
LMS150-SL48	1	5.97kg	6.82kg	8.0kg	L747×W355×H150mm≈0.040 ³
LMS180-SL48	1	5.97kg	6.82kg	8.0kg	L747×W355×H150mm≈0.040 ³
LMS200-SL48	1	5.97kg	6.82kg	8.0kg	L747×W355×H150mm≈0.040 ³
LMS240-SL48	1	7.64kg	8.8kg	9.0kg	L846×W355×H150mm≈0.045 ³
LMS280-SL48	1	7.64kg	8.8kg	9.0kg	L846×W355×H150mm≈0.045 ³

SL48 Street Light

Installation

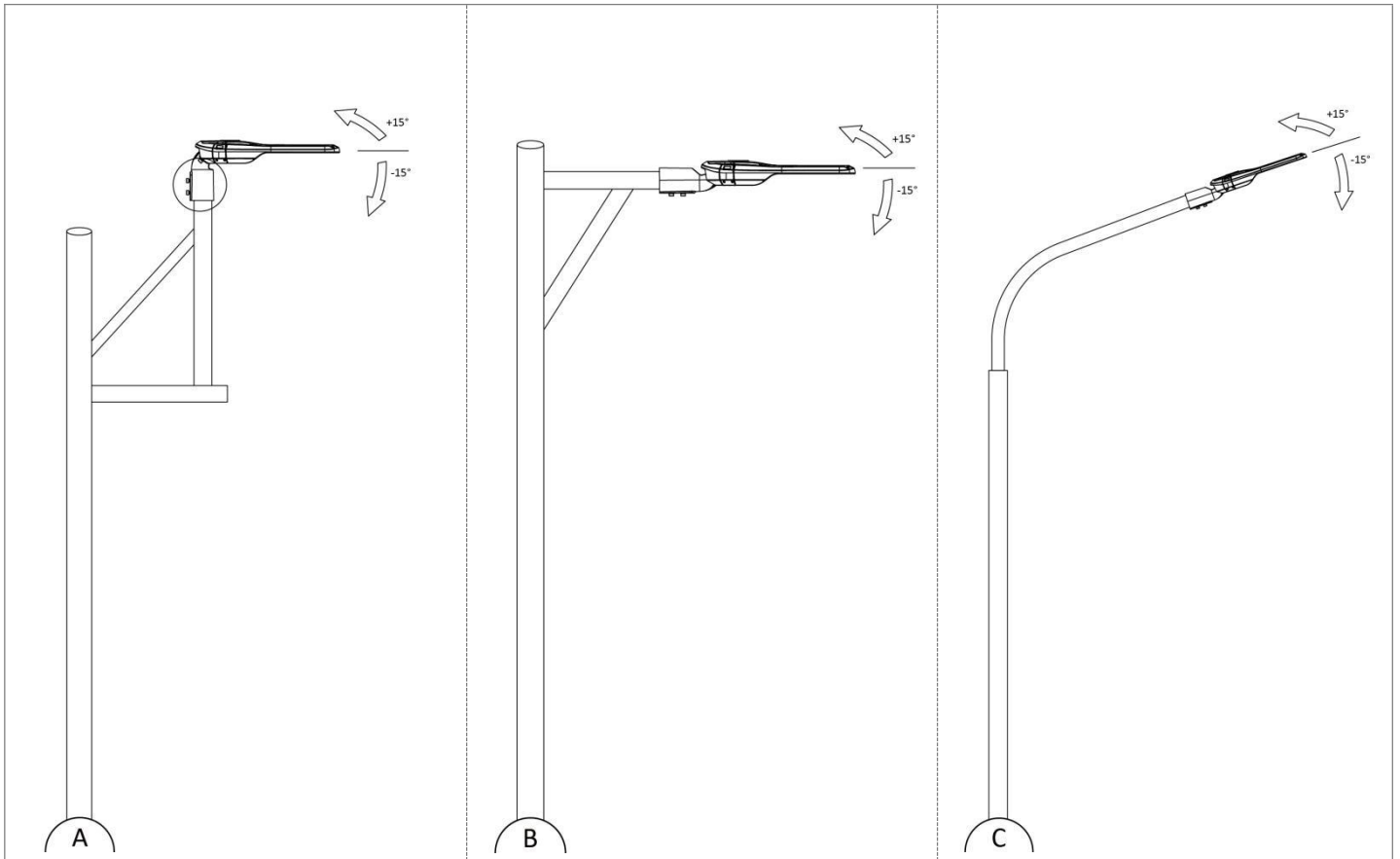

ANSI

White cable for "N"

Green for ground wire

Black cable is for "L"

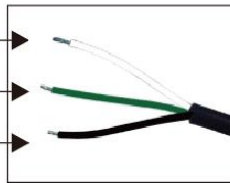

EN

Blue cable for "N"

Brown cable is for "L"



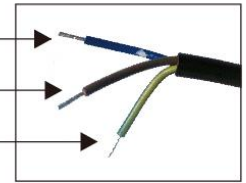



Green/Yellow for ground wire

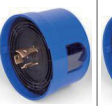
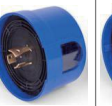
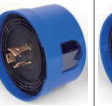
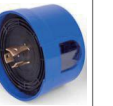

※ Note: If the lamp be used outside, please keep the connector water-proof.

SL48 Street Light

Shorting cap & photocell

LED fixtures match	photocell options		controller base							
			JL-208	JL-205C	JL207C	JL241C	JL251C	JL254C	Gateway box(P/V)	
			"shorting cap Φ73X41MM IP66"	"Analog electronic control three-wire 6Lx ON 50Lx OFF 10s delay Φ84X66MM AC100-277V "	"Digital electronic control three-wire 16Lx ON 24Lx OFF 5-20s delay Φ84X66MM M AC100-277 V"		"0-10V dimming seven-wire 50Lx ON 50Lx OFF 10s delay Φ84X66MM AC100-277V "	"Dali dimming seven-wire 50Lx ON 50Lx OFF 10s delay Φ84X86MM AC100-277V "	"Zigbee control(need work with gateway box) Dali dimming Midnight Dimming LED Decay Compensati on seven-wire 50Lx ON 50Lx OFF 5s delay Φ84X86MM AC100-277V "	remote control by using a gateway box connected to a smart phone(iOS/An driod) with blue tooth communicati on, while connected to the smart control(JL-25 4C) with Zigbee communicati on
										
"SL27,SL29,SL30, SL32,SL48 series non-dimmable"	JL-200X		"S:Φ65X38.5MM,0-480VAC, AWG18#:10A, AWG14#:15A, ULapproval, 3-wire 150MM (match non-dimming)"	✓	✓	✓				
"SL27,SL29,SL30, SL32,SL48 series 0-10V dimmable"	JL-240XB		"S:Φ65X40MM,0-480VAC, AWG18#: 10A, AWG14:15A, ULapproval, 5-wire 150MM (match 0-10V dimming)"	✓			✓			
"SL27,SL29,SL30, SL32,SL48 series 0-10V/ Dali dimmable"	JL-240XA		"S:Φ65X40MM,0-480VAC, AWG18#:10A, AWG14#:15A, ULapproval,7-wire 150MM (match 0-10V/dali dimming)"	✓	✓	✓	✓	✓	✓	